

# Detection of Magnetic Nanoparticles in Lymph Nodes of Rat by High $T_c$ SQUID

Saburo Tanaka, Hajime Ota, Yoichi Kondo, Yasuhiro Tamaki, Shogo Kobayashi, and Shinzaburo Noguchi

**Abstract**—We have proposed a Lymph-node detection system using a high  $T_c$  SQUID gradiometer and ultra-small particles. A rat was injected with a mixture of water diluted superparamagnetic particles. The lymph nodes containing particles were then extracted from the rat. The lymph node samples were measured by a SQUID gradiometer system. We have successfully measured the signal from the lymph node.

**Index Terms**—Biopsy, breast cancer, lymph node, SQUID.

## I. INTRODUCTION

WE have proposed the application of a high- $T_c$  superconducting quantum interference device (SQUID) for sentinel node biopsy, which is a newly developed surgical technology. Axillary lymph-node dissection is an important procedure in the surgical treatment of breast cancer. However, in the early diagnosis stage, the number of dissections in which axillary nodes are free of disease tends to be high. These treatments lead to problems such as a lymph edema and a sensory neuropathy in the patient. Sentinel node biopsy is used to investigate whether the sentinel node, which initially receives malignant cells from a breast carcinoma, is disease-free or not. If the sentinel node is free of disease, it is unnecessary to remove the rest of the lymph-nodes because of no concern for the progression. The principle is shown in Fig. 1. An infected area (primary tumor) is connected with axillary lymph nodes. This biopsy is based on the hypothesis that if the first lymph node (sentinel node: shown as a solid circle in the figure) is free of disease, the second and the rest of the nodes must be also negative. In case of positive (a), all of the lymph nodes should be dissected because of the possibility of the progression in the future. In case of negative (b), you can preserve the rest of the lymph nodes. Two methods which detect the sentinel node have been developed and reported to date [1]–[3]. One is a kind of radio guide, which uses a gamma detector and a radio isotope such as technetium labeled sulfur colloid. After injecting the isotope into a breast

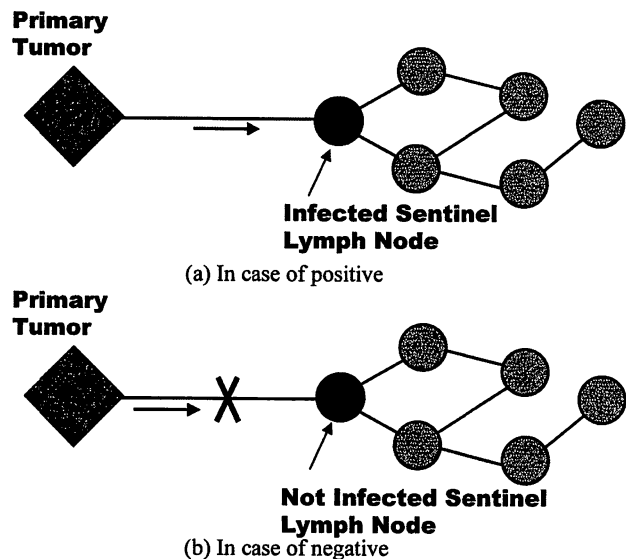

Fig. 1. Principle of the sentinel lymph node biopsy. Sentinel lymph node should be identified by a sensor and remove for the biopsy. After the biopsy, the strategy will be decided. In case of positive (a), all of the lymph nodes should be dissected because of the possibility of the progression in the future. In case of negative (b), you can preserve the rest of the lymph nodes [4].

lesion, the sentinel lymph node will be identified by the gamma detector. Then the sentinel node is excised and examined. In this method the sentinel lymph-node is successfully identified with 94.4% accuracy [1]. Though the predictability of this method is extremely high, radiation exposure is inevitable for the medical staff. The other method uses a blue dye; a surgeon identifies the sentinel lymph-node with his naked eye. With this method, the predictability is still 70% accurate [2].

Therefore we propose a localization system combined with a high sensitivity superconducting quantum interference device (SQUID) gradiometer and ultra-small iron oxide particles. The particles are injected into the breast; and the high- $T_c$  SQUID is used as a sensing detector for the particles. This method has some advantages: no radiation exposure and an accurate identification because of the visible color of the particles themselves. A surgeon identifies colored lymph tube and finds the target sentinel lymph node easily. For this application, the SQUID magnetic sensor should identify the location of the small quantity of particles under the sensor at a distance of several centimeters. Even if the particles are made of iron oxide, if their size becomes too small, they show super-paramagnetic properties. Therefore, some magnetic field should be applied to the particles for detection because they have almost no permanent magnetic dipole at room temperature. Koetitz *et al.* applied a pulse field to the

Manuscript received August 6, 2002. This work was supported in part by a Grant-in-Aid for Scientific Research (B) from the Ministry of Education, Science, Sports and Culture of Japan, Nakatani Electric Measuring Technology Association of Japan, and the Magnetic Health Science Foundation.

S. Tanaka and Y. Kondo are with Toyohashi University of Technology, Toyohashi Aichi 441-8580, Japan (e-mail: tanakas@eco.tut.ac.jp; ep993109@mail.eco.tut.ac.jp).

H. Ota was with Toyohashi University of Technology, Toyohashi Aichi 441-8580, Japan, and is now with Sumitomo Electric Hightechs, Japan (e-mail: ota@shs.co.jp).

Y. Tamaki, S. Kobayashi, and S. Noguchi are with the Department of Surgery and Clinical Oncology, Osaka University Graduate School of Medicine, Osaka 565-0871 Japan (e-mail: tamaki@onsurg.med.osaka-u.ac.jp; s-kobayashi@umin.ac.jp; noguchi@onsurg.med.osaka-u.ac.jp).

Digital Object Identifier 10.1109/TASC.2003.813857

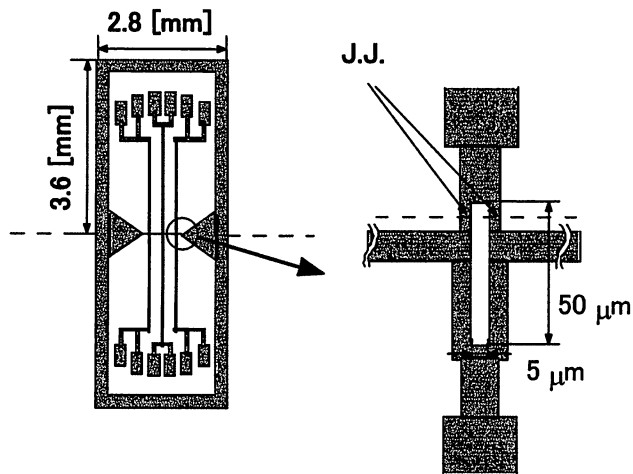

Fig. 2. Design of high  $T_c$  SQUID gradiometer. The SQUID gradiometer is made of  $Y_1Ba_2Cu_3O_{7-y}$  thin film. The junctions utilized in the SQUID are of the step-edge type. The gradiometer is of planer type with a baseline of 3.6 mm. The magnetic flux noise in the white noise region was about  $20 - 30 \mu\phi_0/\text{Hz}^{1/2}$ .

particles and then measured the field decay from the particles in the range of ms [5]. Empuku *et al.* measured the field from the particles under a DC magnetic field [6], [7]. We have already reported the results of a preliminary study using particles dispersed in a liquid contained tube by an AC magnetic field [8].

In this paper, we describe the results of the detection of pseudo-lymph nodes made of balloons, and real lymph nodes extracted from a rat by a SQUID gradiometer.

## II. EXPERIMENTAL SETUP

### A. SQUID Gradiometer

The SQUID gradiometer is made of  $Y_1Ba_2Cu_3O_{7-y}$  thin film. The junctions utilized in the SQUID are of the step-edge type. Fig. 2 shows the design of the SQUID gradiometer. The gradiometer is a planer type which baseline is 3.6 mm. The gradiometer was operated in a flux-locked loop with a flux modulation frequency of 256 kHz. The magnetic flux noise in the white noise region was about  $20 - 30 \mu\phi_0/\text{Hz}^{1/2}$ . The measured effective area as a magnetometer was  $0.13 \text{ mm}^2$ . This value was measured by cutting one pickup loop of the two.

### B. Measurement

The cryostat was specially designed for a SQUID microscope. The SQUID sensor was located inside a vacuum and separated by a  $500 \mu\text{m}$  thick quartz window. A more detailed description can be found elsewhere [9]. A 750 turns wound coil for magnetization was mounted just above the SQUID microscope [10]–[12]. This coil can generate magnetic field of up to  $8 \times 10^{-4} \text{ T}$ .

All of the experiments were performed inside a magnetically shielded room (MSR), with a shielding factor of  $-50 \text{ dB}$  at DC. The schematic diagram of the system is shown in Fig. 3. A balloon sample on a polyethylene sheet was drawn by an induction motor installed outside the MSR. A 750 turns wound coil was on the cryostat. The bore size was 6 mm in diameter.

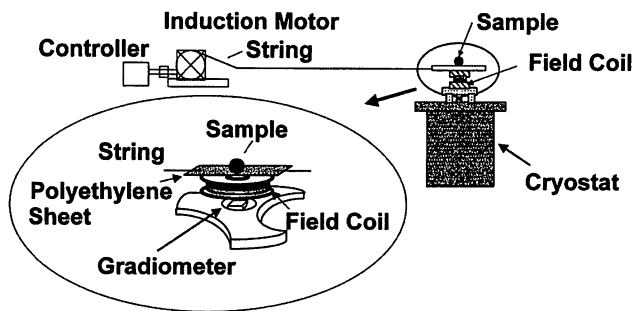

Fig. 3. Schematic diagram of the measurement system. A 750 turns wound coil was on the cryostat. The bore size was 6 mm in diameter. The SQUID gradiometer position was carefully adjusted before measurement, so that the SQUID output signal without particles became almost zero. Then the sample was moved under a dc magnetic field of  $4 \times 10^{-4} - 8 \times 10^{-4} \text{ T}$ .

A dc current was directed to the coil. The magnetic field generated from the coil can magnetize a sample above the coil. The distance between the sample and the SQUID was 7 mm. The SQUID gradiometer position was carefully adjusted before measurement, so that the SQUID output signal without particles was almost zero. After adjusting the SQUID position, the sample was moved with a scan speed of  $0.3 - 1.0 \text{ mm/sec}$  under a dc magnetic field of  $4 \times 10^{-4} - 8 \times 10^{-4} \text{ T}$ . We note that the both of white and low frequency noise remain constant for the magnetic field in this range.

### C. Samples

We used ultra-small particles from Meito Sangyo Co., Ltd. Similar particles are used as a magnetic resonance imaging (MRI) contrast agent. The core of the particle is iron oxide  $\text{Fe}_3\text{O}_4$  (magnetite) which is coated with an alkali-treated dextran. The average core diameter was 11 nm. The particles had superparamagnetic properties. The particles were supplied in the form of an aqueous magnetic fluid. The original fluid contained 5.9 mg/ml of iron. If we suppose  $5.2 \text{ g/cm}^3$  as the specific gravity of the core, we can estimate the weight of the mono-particle as  $3.6 \times 10^{-18} \text{ g}$  and the total number of particles in the original solution as  $1.5 \times 10^{16}/\text{ml}$ . The original fluid was diluted with distilled water to have the desired concentrations. Then the diluted fluid was wrapped with a latex film as shown in Fig. 4. The outer dimension of the balloon is 3 mm in diameter. We used the balloon sample as a pseudo lymph node during our experiment.

### D. Animals

Male Wister Shionogi rats (WS; Shionogi Aburabi Laboratory, Shiga, Japan, 10 weeks old) weighting 290–320 g were used in the following experiments. The rats were kept in a temperature-controlled room with a 12-hour light-dark cycle and acclimated for at least 7 days before use. All animals had free access to water and standard laboratory diet (Oriental Yeast Co, Ltd, Tokyo, Japan). All procedures were performed under pentobarbital anesthesia ( $50 \text{ mg/kg}$ , i.p.), and all experiments were carried out in compliance with guidelines on the care and use of laboratory animals from Osaka University.

The hind legs of a rat were injected with a mixture of water diluted particles and lymphazurin which was used as a color dye

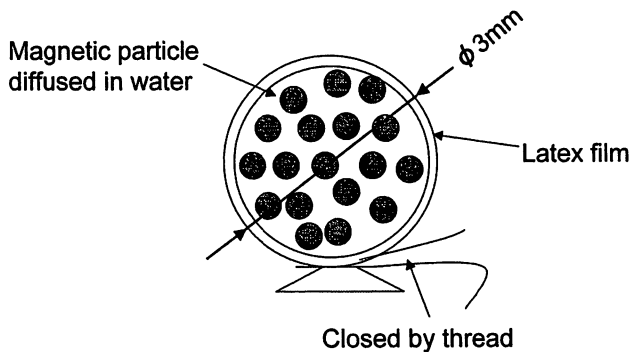

Fig. 4. Schematic drawing of a pseudo lymph node sample [10]. The original fluid was diluted with distilled water to have the desired concentrations. Then the diluted fluid was wrapped with a latex film.

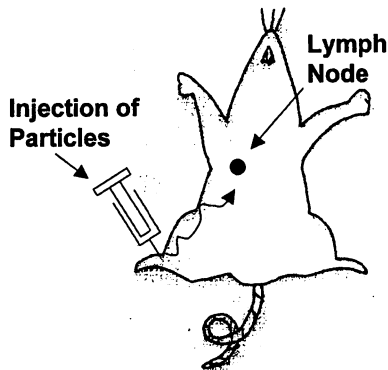

Fig. 5. Schematic drawing of the preparation of lymph nodes of rat. The hind legs of a rat were injected with a mixture of water diluted particles and lymphazurin which was used as a color dye for a human lymph node operation. After 5 minutes, the particle contained lymph nodes were then extracted from the rat.

for a human lymph node operation. The total volume was  $200 \mu\text{l}$  and the iron content of the mixture was  $24.5 \mu\text{g}/\mu\text{l}$ . Thus a total mass of  $4.9 \text{ mg}$  iron was injected to the rat. After 5 minutes, the particle containing lymph nodes were then extracted from the rat (Fig. 5). The samples initially underwent fixation in formaldehyde to preserve structure. Following fixation, the samples were dehydrated in graded ethanol-water mixtures, and embedded in paraffin wax.

### III. RESULTS AND DISCUSSION

#### A. Pseudo Lymph Node

All of the measurements were performed in a magnetically shielded room with a shielding factor of  $-50 \text{ dB}$  at  $0.1 \text{ Hz}$ . Fig. 6 shows the typical output signal of the gradiometer when the spherical sample passed above the coil. The weight of iron in the fluid was calculated as  $25 \mu\text{g}$ . The measurement was performed under the dc applied magnetic field of  $6.4 \times 10^{-4} \text{ T}$ . In this measurement the distance from the sensor to the specimen was  $6 \text{ mm}$ . Large positive and negative peaks are observed. Each positive and negative peak was recorded when the sample was above each pickup loop of the gradiometer. We define peak to

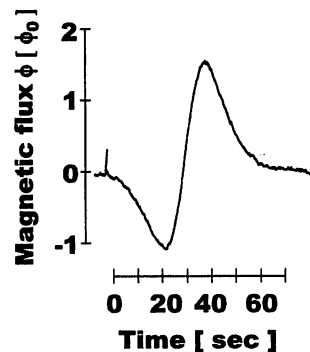

Fig. 6. Typical output signal when a spherical sample passed above the gradiometer. Large positive and negative peaks are observed.

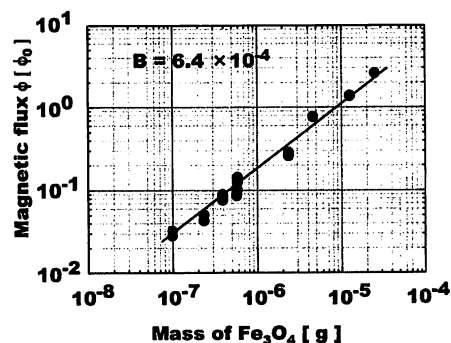

Fig. 7. Magnetic signal intensity from pseudo lymph node sample versus weight of Fe in particle. Particles of  $100 \text{ ng}$  in weight of iron could be detected with a spacing of  $6 \text{ mm}$ .

peak voltage as a output signal. It corresponds to the weight of the iron.

We investigated the detectable weight of the iron at a distance of  $6 \text{ mm}$ . As shown in Fig. 7, the SQUID signal was proportional to the weight of the iron in the fluid. Particles of  $100 \text{ ng}$  in weight of iron could be detected with a spacing of  $6 \text{ mm}$ .

#### B. Rat Lymph Node

Then lymph nodes retrieved from a rat were used as samples. The dimension of the sample is about  $6 \text{ mm} \times 3 \text{ mm} \times 1 \text{ mm}$  (Length  $\times$  Width  $\times$  Thickness). The measurement conditions were the same as for the pseudo samples. Fig. 8 shows the dependence of the signal on applied magnetic field. The signal intensity was fairly large and  $1250 m\phi_0$  at a magnetic field of  $6.4 \times 10^{-4} \text{ T}$ . The iron content of the lymph node sample can be calculated as  $10 \mu\text{g}$  from the results of the pseudo sample shown in Fig. 7. This value correspond to  $0.2\%$  of the injected iron. Although it is difficult to estimate the accumulated weight of iron particles for the human case, we think it must be more than  $10 \mu\text{g}$  because the volume of the injection must be 20 times larger than that of the rat. This performance is good enough to apply this system to the real sentinel lymph node biopsy. The effective area of our gradiometer is  $0.13 \text{ mm}^2$ . If supposing the magnetic field from the sample is uniform, then  $\phi_0$  corresponds to about  $15 \text{ nT}$ . This value is large enough for a high  $T_c$  SQUID and also might be detected by other sensors e.g., a magnetoresistive sensor or a flux gate sensor. A test for a large animal should

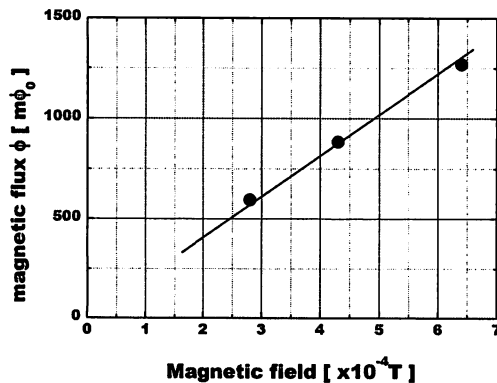

Fig. 8. Applied magnetic field dependence of the signal. The sample was the rat's lymph node containing superparamagnetic nano-particles. The signal intensity was fairly large and 1250  $m\phi_0$  at magnetic field of  $6.4 \times 10^{-4}$  T.

be performed before applying for human to estimate signal intensity from the lymph. One should also know that more sensitivity needs for the real SQUID biopsy with a distance of several centimeters. We can determine if the SQUID is the only sensor which can be used for sentinel node biopsy in the near future.

#### IV. CONCLUSION

We have demonstrated the possibility of sentinel lymph node biopsy using a high- $T_c$  SQUID gradiometer. Pseudo spherical lymph nodes and real rat's lymph nodes were used as samples. The ultra-small iron oxide particles of 100 ng in weight of iron could be detected with a spacing of 6 mm under dc magnetic field. Rat's lymph nodes containing iron oxide particles were measured by the same system. We could successfully measure the signal from the rat's lymph node. The estimated weight of the lymph node was 10  $\mu\text{g}$ . The resolutions are good enough to apply the technology for a Sentinel-node biopsy and a lymphatic mapping.

#### REFERENCES

- [1] U. Veronesi, G. Paganelli, V. Galimberti, G. Viale, S. Zurrada, M. Bedoni, A. Costa, C. de Cicco, J. G. Geraghty, A. Luni, V. Sacchini, and P. Veronesi, "Sentinel-node biopsy to avoid axillary dissection in breast cancer with clinically negative lymph-nodes," *The Lancet*, vol. 349, pp. 1864–1867, 1997.
- [2] A. E. Giuliano, D. M. Kirgan, J. M. Guenther, and D. L. Morton, "Lymphatic mapping and sentinel lymphadenectomy for breast cancer," *Ann Surg*, vol. 220, pp. 398–401, 1994.
- [3] C. E. Cox, S. P. Pendas, J. M. Cox, E. Joseph, A. R. Shons, T. Yeatman, N. N. Ku, G. H. Lyman, C. Berman, F. Haddad, and D. S. Reintgen, "Guidelines for sentinel node biopsy and lymphatic mapping of patients with breast cancer," *Annals of Surgery*, vol. 227, pp. 645–653, 1998.
- [4] Y. Katayose, Private Communication, July 2002.
- [5] R. Koetitz, H. Matz, L. Trahms, H. Koch, W. Weitschies, T. Rheinlaender, W. Semmler, and T. Bunte, *IEEE Trans. Appl Supercond.*, vol. 7, p. 3678, 1997.
- [6] R. Engelhardt, R. Fischer, P. Nielsen, and E. E. Gabbe, "Iron quantification by noninvasive biomagnetic organ susceptometry," in Proc. of 10th International Conference on Biomagnetism, 1996.
- [7] K. Enpuku, T. Minotani, T. Gima, Y. Kuroki, Y. Itoh, M. Yamashita, Y. Katakura, and S. Kuhara, "Detection of magnetic nanoparticles with superconducting quantum interference device (SQUID) magnetometer and application to immunoassays," *Jpn. J. Appl. Phys.*, vol. 38, pp. L1102–1105, 1999.
- [8] S. Tanaka, A. Hirata, Y. Saito, T. Mizoguchi, Y. Tamaki, I. Sakita, and M. Monden, "Application of high  $T_c$  SQUID magnetometer for sentinel-lymph node biopsy," *IEEE Transactions on Applied Superconductivity*, vol. 11, pp. 665–668, 2001.
- [9] S. Tanaka, O. Yamazaki, R. Shimizu, and Y. Saito, "Windowless high  $T_c$  superconducting quantum interference device microscope," *Jpn. J. Appl. Phys.*, vol. 38, pp. L505–507, 1999.
- [10] S. Kumar, R. Matthews, S. G. Haupt, D. K. Lathrop, M. Takigawa, J. R. Rozen, S. L. Brown, and R. H. Koch, "Nuclear magnetic resonance using a high temperature superconducting quantum interference device," *Appl. Phys. Lett.*, vol. 70, pp. 1037–1039, 1997.
- [11] K. Schlenga, R. McDermott, J. Clarke, R. E. de Souza, A. Wong-Foy, and A. Pines, "Low-field magnetic resonance imaging with a high- $T_c$  dc superconducting quantum interference device," *Appl. Phys. Lett.*, vol. 75, pp. 3695–1697, 1999.
- [12] S. Tanaka, T. Mizoguchi, H. Ota, and Y. Kondo, "Lymph-node detection system using a high  $T_c$  SQUID and ultra-small particles," *IEICE Transactions Electron.*, vol. E85-C, no. 3, pp. 687–690, 2002.